

**Custom Sanitary Shell & Tube Heat Exchangers**

# ABC also designs and fabricates industrial shell and tube heat exchangers

Allegheny Bradford Corporation produces a range of Shell & Tube industrial heat exchangers in 304, 316L, high chromium alloy's and Titanium for the most demanding applications.

Whether Straight-Tube, U-tube, or Coil design, ABC provides a custom designed heat exchanger tailored to your exacting requirements to maximize the performance and efficiency for your process.

Features include:

- 100% vibrational and acoustic resonance analysis.
- All multi-pass exchangers, straight-tube or U-tube, include accurate counter-current and co-current flow analysis.
- U-tube exchangers can include removable tube bundles allowing for cleaning, maintenance and inspections.
- Precise expansion and contraction calculations are performed on all straight-tube exchangers to determine expansion joint necessity. (Expansion joints are not needed for U-tube designs).
- Reynolds Numbers are reported with each design to report the efficiency of the design.
- Precise tube side and shell side pressure drop calculations are reported with every design. (Based on the allowable pressure drop per your specifications).
- TEMA recommended fouling factors are calculated and provided with every design.
- Unsurpassed document control department to ensure receipt of all necessary validation documentation.



Allegheny Bradford heat exchangers are used in many industries:



**Food and Beverage**



**Chemical/Industrial**



**Electronic/Semiconductor**



**Wood/Paper**

# We set the standard in the pharmaceutical industry!

## ABC knows BPE

- Allegheny Bradford is actively involved in multiple Bioprocessing Equipment (BPE) subcommittees, ensuring we have a voice in every specification decision.
- We provide the highest quality BPE-compliant heat exchangers and an unsurpassed Turn Over Package, which exceeds all pharmaceutical industry validation requirements.

### ABC Custom Heat Exchangers =

Consistent Performance, Reduced Maintenance, and Extended Equipment Life.

Types of heat exchangers we design include:

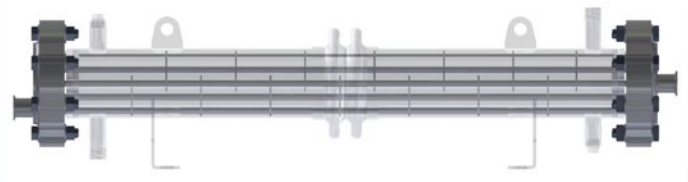
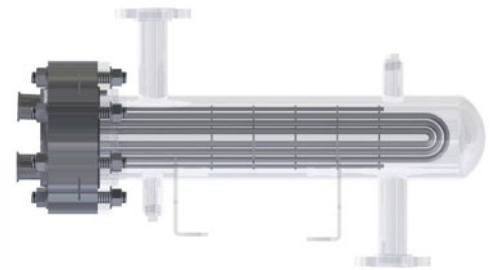
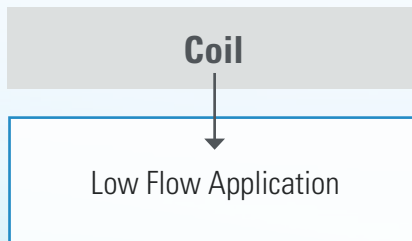
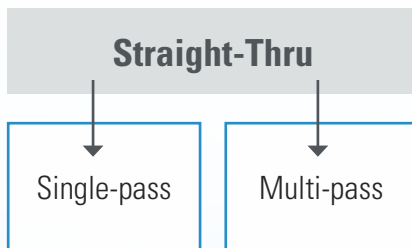
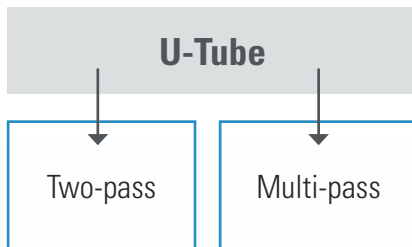

**Complete SS or (high alloy) construction**

• 304L & 316L • Titanium • UNS N10276 • UNS N08367 • Other alloys upon request

# Every Allegheny Bradford heat exchanger is custom

## Features

Double Tube Sheet

ABC's insulation jacket

ABC utilizes hydraulic tube expansion

## Benefits

Eliminates the possibility of cross contamination

Allows for independent expansion of the heat exchanger eliminating stress on the shell side inlet and outlet ports

- Eliminates spiral stress and work hardening
- Minimizes damage to tube finish

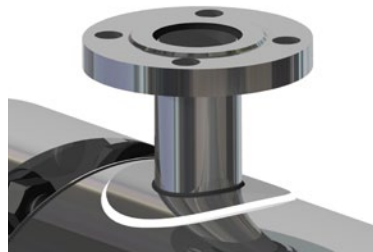
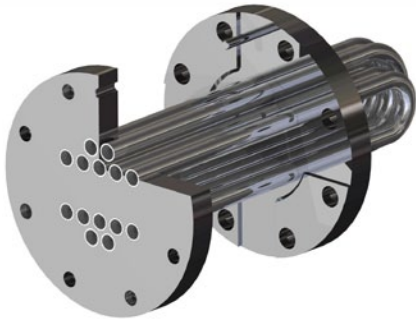

Prior to shipment, every heat exchanger undergoes rigorous testing and documentation procedures that can include:

- Hydrostatic pressure testing
- Dye penetration examination
- Radiography
- Steam testing
- Positive Material Identification (PMI)
- Profilometer readings of surface finish to ensure surface finishes to less than 10 microinches Ra.
- Ferrite testing
- Drainage testing
- Saline testing
- Computer-verified performance
- Fiber optic, borescopic tube inspection and videotaping of product contact surfaces on DVD

You receive complete documentation to comply with your requirements, including data reports, seismic calculations, production drawings, material test reports, and certifications of hydrotest, passivation, surface finish and electropolishing.



# designed to meet your exact requirements

Fully radiused pass pockets

Offers industry's best drainability



Advanced thermal & mechanical design

Ensures:

- 100% analysis of process vibration and acoustic resonance
- Process - specific Reynolds Numbers
- Precise pressure drop calculations (tubeside and shellside)
- TEMA - recommended fouling factors to your specific media

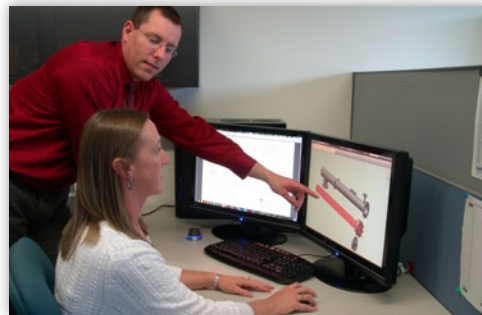

Team of dedicated professionals who are committed to the responsive customer service YOU need!

Provide you with products that deliver unparalleled performance and dependability



## Complete Certification



CE



UM ASME VIII Stamp



U ASME VIII Stamp



Chinese License

## Codes & Standards

- UL-508A
- ASME
- CRN
- Bioprocessing Equipment Standards Committee
- GMP
- 3-A
- Ministry of Manpower (MOM)
- The National Board of Boiler and Pressure Vessel Inspectors
- ASTM
- TEMA



Allegheny Bradford offers a full range of products:



**Allegheny Bradford Corporation**



Get the free mobile app at  
<http://gettag.mobi>

P.O. Box 200  
Bradford, PA 16701  
814-362-2590 or 800-542-0650  
Fax: 814-362-4674  
[sales@alleghenybradford.com](mailto:sales@alleghenybradford.com)

[www.alleghenybradford.com](http://www.alleghenybradford.com)

BRC-HES